

Setra Wood Products Ltd

Product Catalogue 2024



 **Setra**

We create green value.

A young evergreen tree sapling, possibly a spruce or fir, stands in the center of the frame. It has a thin, light brown trunk and several branches covered in dense, vibrant green needles. The background is a soft-focus natural setting with various green plants, some with small white flowers, and reddish-brown rocks. The sky is a pale, clear blue. The overall scene conveys a sense of growth and nature.

We create green value.

Grönsamhet.

[Gruhn-sahm-hyet]

Where there's people, there should be wood. Wood makes life simpler and more beautiful. It's just as durable as many other materials – and a lot more sustainable than most of them. Simply put – the more wood there is, the more our planet rejoices.

We want to do business where everyone prospers – not just ourselves but also our customers, nature and society. This is what we call “Grönsamhet”.

If you look up a translation for what “Grönsamhet” means, you're not going to find one. And that's because we came up with it by using the Swedish word for “green” and the word for “profit”. And this encompasses what we aspire to. We want to create sustainable profits that benefits all. And we have all the possibilities in the world to do so. Because the wood business is very good business, if one wants to reach the goal of Grönsamhet. Which we do.

Read more about Grönsamhet at: www.setrawoodproducts.com



We create green value.

Sawn & processed wood products from responsibly managed forests.

Raw material in both pine and spruce is sourced from forests near our sawmills and planing mills. We are located in the northern and central parts of Sweden, one of the world's best raw material areas for softwood.

Our wood products are of high quality and have a densely grown and fine structure. Setra's customers are in the industrial and construction industries, and building materials trade worldwide.





SETRA DECK

16

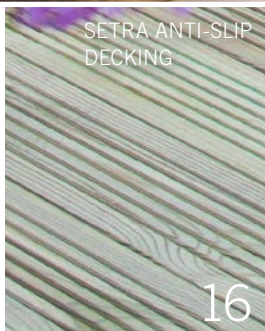

SETRA ANTI-SLIP DECKING

16

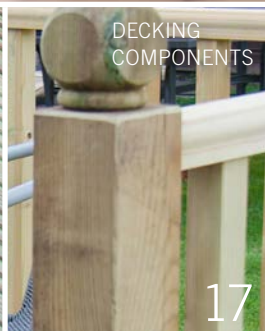

DECKING COMPONENTS

17



TREATED SLEEPERS

18



SAWN PRODUCTS

19



C24 CARCASSING

20



TR26

21



STRUCTURAL GLULAM

22

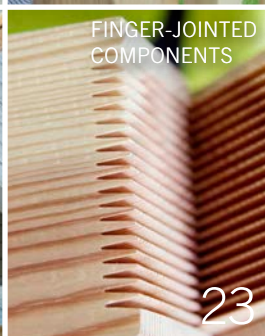

FINGER-JOINTED COMPONENTS

23



EXCELLENCE IN SPECIAL MACHINING

24

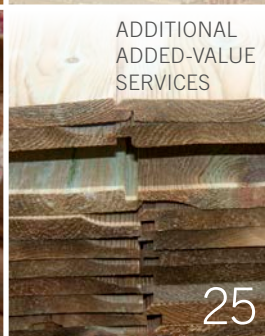

ADDITIONAL ADDED-VALUE SERVICES

25



ENVIRONMENTAL AND SUSTAINABILITY

26

PAR/PSE Sections

Whitewood and Redwood Planed All Round and Planed Square Edged sections are available in a range of grades to suit budget and end use. All are machined to the same high standard.

We offer either packaged to length 3.6m and longer or truck bundled lengths on most of our range of PAR/PSE softwood. Full sets are approximately 1.0m³. Most sections can be split down to smaller volumes for a small premium.

We are also pleased to offer a range of sizes in cross-cut lengths of 2.1m, 2.4m and 3.0m. Contact our sales team for full details of our specifications and prices.



Laminated

We offer both redwood and whitewood laminated products. The lamination process allows manufacturing of wide section sizes, which can be troublesome in solid timber form.



Whitewood PAR / PSE

Nominal Width (mm)	Nominal Thickness (mm)			
	22	25	32	38
50	X			
75	X			
100	X			
115			X	
125	X			
138			X	
150	X			
175	X			
200	X			
225	X			

Redwood PAR / PSE

Nominal Width (mm)	Nominal Thickness (mm)									
	12	16	19	25	32	38	50	63	75	100
25	X		X	X						
38	X	X	X	X	X	X				
50	X	X	X	X	X	X	X			
75	X		X	X	X	X	X		X	
100	X		X	X	X	X	X	X	X	X
115						X				
125			X	X		X	X			
138						X				
150			X	X	X	X	X		X	
175				X	X	X				
200				X	X		X			
225				X	X	X	X			

Laminated

Nominal Thickness (mm)	Nominal Width (mm)			
	Profile	Wood Type	Finish Size	100 250 275
100	PAR	Redwood	90x90	2 Piece Laminated X
32	PAR	Redwood	27x269	9 Piece Laminated X
32	PAR & Nosed	Redwood	27x240	2 Piece Laminated X
25	PAR	Whitewood	20x269	6 Piece Laminated X
38	PAR	Whitewood	33x269	6 Piece Laminated X



Architraves

Architraves are machined from selected high quality Scandinavian redwood and are finished to our usual high standard.

Architraves

Nominal Thickness (mm)	Profile	Nominal Width (mm)		
		50	63	75
19	Chamfered	X		X
19	Bullnose	X		X
25	Ogee	X	X	X
25	Torus		X	X

Chamfered

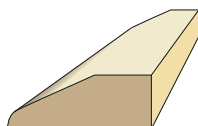

Bullnosed

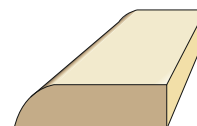

Ogee

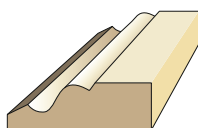

Torus

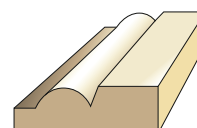

Skirtings

Skirtings are machined from selected high quality Scandinavian redwood and are finished to our usual high standard.

Skirting

Nominal Thickness (mm)	Profile	Nominal Width (mm)					
		75	100	125	150	175	225
19	Chamfered / Bullnosed	X	X	X			
19	Chamfered	X					
25	Torus/Ogee			X	X	X	X
25	Chamfered/Ovolo				X	X	

Chamfered/Bullnosed

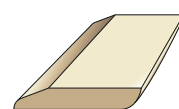

Bullnosed

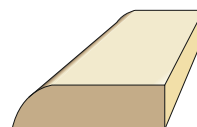

Chamfered

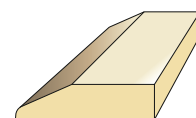

Torus/Ogee

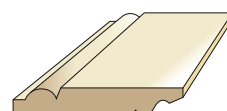

Chamfered/Ovolo

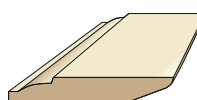

MDF Mouldings

Moisture-resistant MDF is used to produce our range of quality mouldings (including dual-profile skirtings). A machine-applied white primer coat gives the ideal base for final finishing.

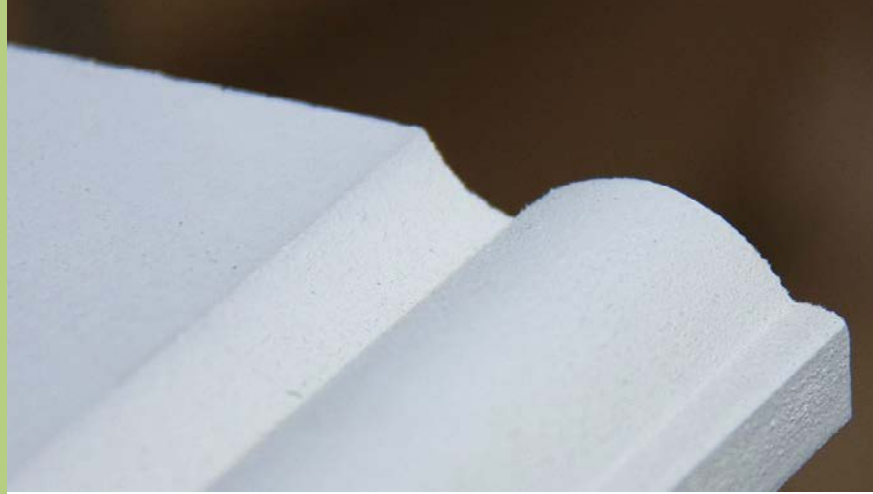

Redwood

Nominal Thickness (mm)	Profile	Nominal Width (mm)													
		44	58	69	94	119	145	169	195	219	220	244	294		
14	Chamfered	X		X											
14	Bullnosed	X		X											
14	Chamfered/ Bullnosed			X	X										
18	Torus		X	X											
18	Ogee		X	X											
18	Grooved Contemporary			X			X								
18	Ovolo			X											
18	Bullnosed			X			X								
18	Chamfered			X											
18	Torus/Ogee						X	X	X			X			
18	Chamfered/ Ovolo							X							
25	Windowboard							X	X	X	X			X	X

Chamfered Architrave

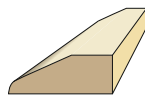

Chamfered Skirting

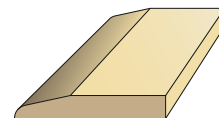

Torus Architrave

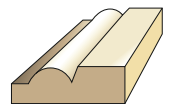

Ogee Architrave

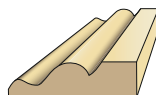

Torus / Ogee Skirting

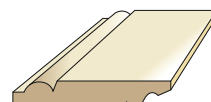

Windowboard

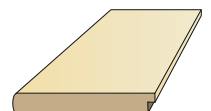

Grooved
Contemporary
Architrave

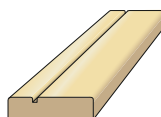

Grooved
Contemporary
Skirting

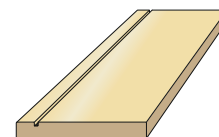

Claddings

Available in stock patterns, or machined to customer's own profile. Designed to provide any interior project with the warmth of natural wood, or use preservative-treated for an external building or garden project.



PTGV or PMV

Nominal Thickness (mm)	Nominal Width (mm)		
	100	125	150
13	X		
16	X	X	
19	X	X	X
25		X	X

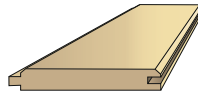

Beaded PMV

Nominal Thickness (mm)	Nominal Width (mm)		
	100	125	150
13	X		
19			X

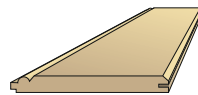

Shiplap

Nominal Thickness (mm)	Nominal Width (mm)			
	Profile	100	125	150
16	Rebated		X	
16	T&G		X	
19	Rebated		X	X
22	Loglap	X		
25	Rebated			X

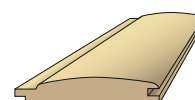
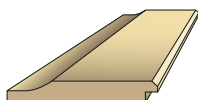

X Treated UC3u Cladding available ex stock.

Floorings

Available in stock patterns or can be machined to order. Swedish manufactured high quality flooring also available.



PAR

Nominal Thickness (mm)	Wood Type	Nominal Width (mm)				
		125	150	175	200	225
22	Whitewood	X	X	X	X	X
25	Redwood	X	X	X	X	X

PTG

Nominal Thickness (mm)	Wood Type	Nominal Width (mm)		
		125	150	175
22	Whitewood	X	X	
25	Redwood	X	X	X

PTG Whitewood

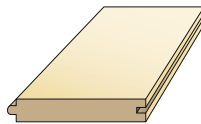

PTG Redwood

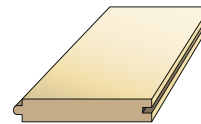

Window Sections

Produced from selected slow-grown softwood to ensure stability and quality. Can be machined to customer patterns.



Window Sections

Nominal Thickness (mm)	Profile	Nominal Width (mm)					
		50	63	100	150	175	225
32	Window Board				X	X	X
32	Nosing	X		X			
50	Stormboard		X				
50	Cill				X		
75	Window Cill				X		

Windowboard

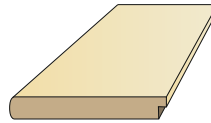

Nosing

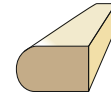

Stormboard

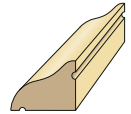

Cill

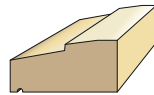

Window Cill

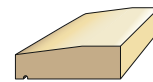

Handrails and Decorative Mouldings

Produced from selected slow grown softwood to ensure stability and quality. Can be machined to customer patterns.



Handrails Nominal Thickness 50mm

Nominal Thickness (mm)	Profile	50	75	125
50	Mopstick	X		
50	Pigs Ear / Wall Fix			X
50	Crown		X	

Mopstick Handrail

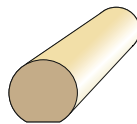

Wall Fix Handrail

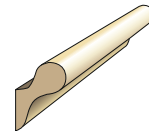

Crown handrail

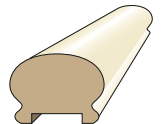

Decorative Mouldings

Nominal Thickness (mm)	Profile	Nominal Width (mm)		
		50	63	75
25	Base Rail			X
25	Picture Rail	X		
25	Picture Rail		X	
25	Dado Rail	X		
25	Dado Rail		X	
25	Dado Rail			X

Base Rail

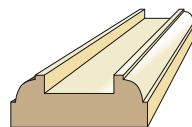

Picture Rail

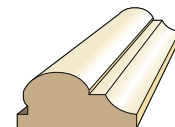

Dado Rail

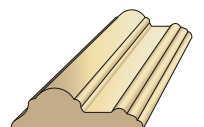

Decorative Small Mouldings

Produced from selected slow grown softwood to ensure stability and quality. Can be machined to customer patterns.

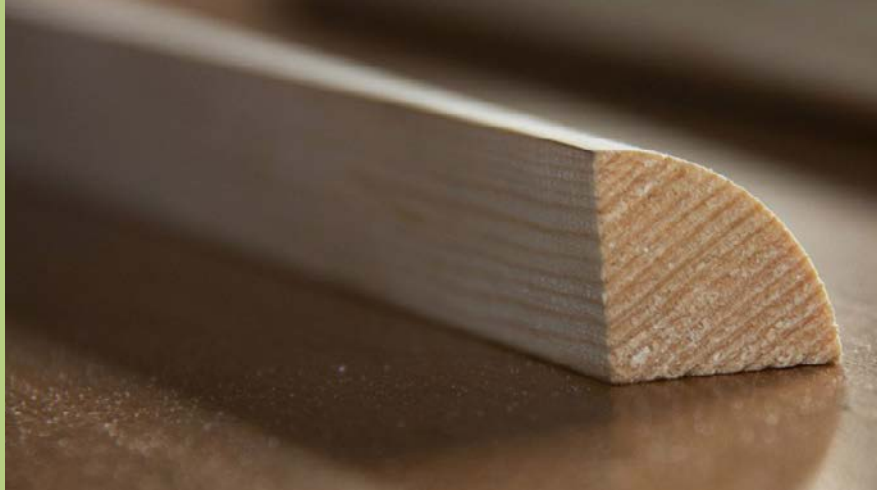

Window Sections Quadrant & Scotia

Nominal Thickness (mm)	Profile	Nominal Width (mm) Finish Size	Nominal Width (mm)				
			12	16	19	22	25
12	Quadrant	9x9	X				
16	Quadrant	12x12		X			
19	Quadrant	15x15			X		
22	Quadrant	18x18				X	
25	Quadrant	21x21					X
25	Scotia	21x21					X

Astragal, Ogee Panel Mould, Barrel Mould, Broken Ogee Mould & Cushion Corner

Nominal Thickness (mm)	Profile	Nominal Width (mm) Finish Size	Nominal Width (mm)			
			25	32	38	50
12	Ogee Panel Mould	9x21	X			
12	Ogee Panel Mould	9x28		X		
12	Barrel Mould	9x21	X			
12	Broken Ogee Mould	8x21	X			
12	Astragal	8x20	X			
12	Parting Bead	8x21	X			
12	Parting Bead	8x27		X		
16	Ogee Panel Mould	12x34			X	
16	Astragal	12x34			X	
19	Staff Bead	15x21	X			
19	Staff Bead	15x27		X		
25	Cushion Corner	21x21	X			
38	Cushion Corner	32x32			X	
50	Cushion Corner	40x40				X

Door lining/casing sets

Produced from Setra's high quality spruce. Each set is inspected for quality before being packaged.

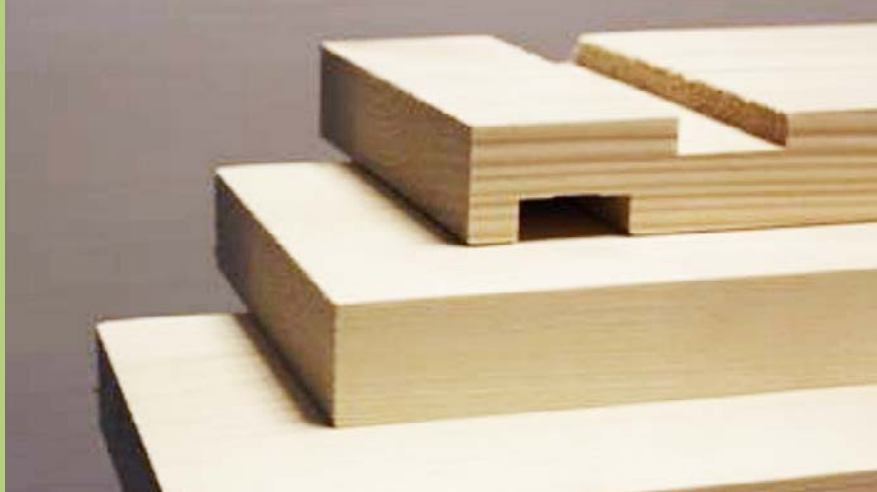

Door Linings

Nominal Thickness (mm)	Profile	Wood Type	Nominal Width (mm)				
			100	115	125	138	175
32	Inc Stop 2'3/2'6 Heads	Whitewood		X		X	
32	Inc Stop 2'6/2'9 Heads	Whitewood	X	X		X	
32	No Stop 2'3/2'6 Heads	Whitewood		X		X	
32	No Stop 2'6/2'9 Heads	Whitewood		X		X	
32	No Stop 2'6/2'9 Heads	Redwood					X
32	Inc Stop 2'6/2'9 Heads	Redwood			X		
38	Inc Stop 2'3/2'6 Heads	Redwood		X		X	
38	Inc Stop 2'6/2'9 Heads	Redwood		X		X	

Doorstops

Nominal Thickness (mm)	Profile	Nominal Width (mm)	
		38	50
16,7	PSE	X	X
16,7	Ovolo	X	X
19	PSE	X	X
32	PSE	X	X

Certifire Door Linings

High quality softwood Certifire door linings, are manufactured from slow grown premium redwood timber, which has been precision finished and fully machined.

Certifire Door Lining sets should be used with specified CERTIFIRE approved doors and fixings.

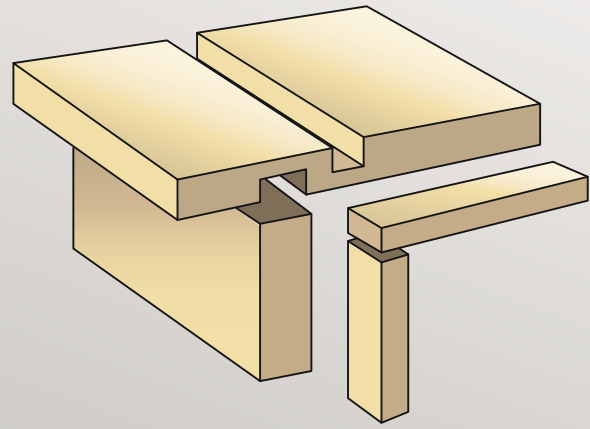

Certifire Grooved Door Linings

Nominal Thickness (mm)	Profile	Wood Type	Nominal Width (mm)	
			115	138
38	Inc Stop 2'3/2'6 Heads	Redwood	X	X
38	Inc Stop 2'6/2'9 Heads	Redwood		X



APPROVED PRODUCT CAF 5075

Setra Deck

Produced from Swedish pine, our treated decking ensures consistent durability and quality.

Setra Anti-Slip Decking

A factory applied, machined process, which can be applied to any of our softwood decking profiles, transforming them into safer, anti slip surfaces.

The specially formulated combination of resin and aggregate provides a robust solution to the hazards posed in slippery conditions, and is ideal for both domestic and commercial applications.



Swedish Redwood Decking (UC3u Green Treated)

Nominal Thickness (mm)	Nominal Width (mm)	Profile	125	150
32		"NYBY"		X
38		"MALA"	X	
32		"KASTET"	X	
32		"FARILA"		X

NYBY

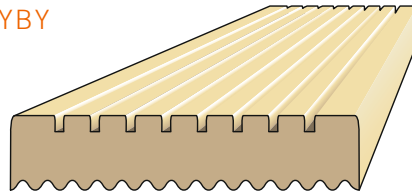

MALA

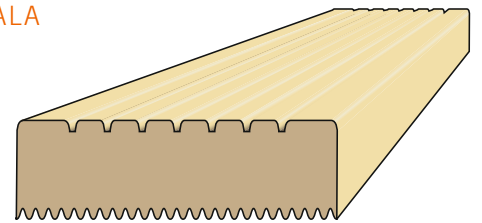

KASTET

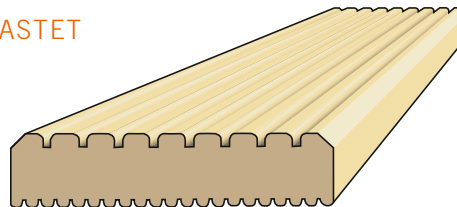

FARILA

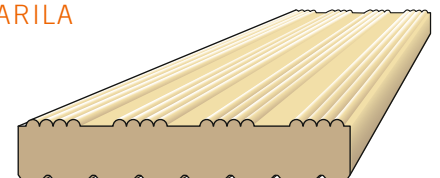



Decking Components

Produced from high quality redwood and UC3u pressure-treated for increased durability. The perfect way to enhance and complete any decking project.

Components

Profile	Thickness (mm)		Width (mm)				
	41	68	70	83	93	115	
33 Reversible Hand/Base Rail				X			
33 Base Rail				X			
41 Turned Spindles	X						
41 Stop Chamfered Spindles	X						
41 Blank Spindles - Eased Corners	X						
44 Hand/Base Rail inc Fillet		X					
83 Weathered Top Deck Post					X		
83 Turned Deck Post inc Ball Cap					X		
93 Blank Spindles - Eased Corners						X	
115 Newel Cap						X	

Rev. Hand/Base Rail Turned Deck Post inc Ball Cap

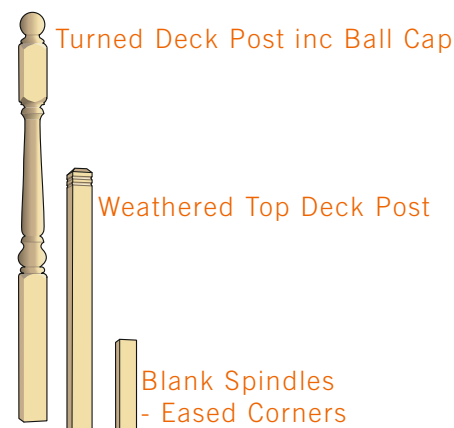
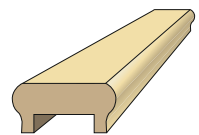

Hand/Base Rail inc Fillet

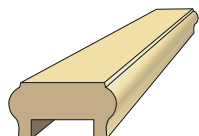

Weathered Top Deck Post

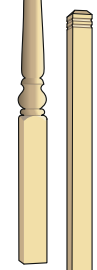

Base Rail

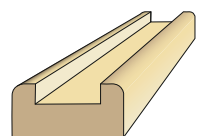

Blank Spindles - Eased Corners

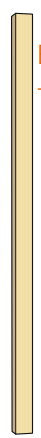

Stop Chamfered Spindles



Newel Cap

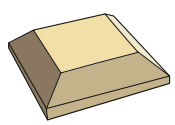

Turned Spindles



Treated Sleepers

Sleepers pressure treated with either green or brown preservative.

Available in odd packs to full loads.



Treated Sleepers 2.4 m

Finish Thickness (mm)	Finish Width (mm)	
	195	200
95	X	
100		X

Battens

BS Graded Battens produced using quality sawn from our Setra mills which is consistent and reliable to the UK required specification.

Ex Stock available in Full Loads or as part of a combination delivery.



25x50 UC2 Treated BS Battens Available stock lengths may vary

Nominal Thickness (mm)	Nominal Width (mm) and Finish Size	
	Lengths	50 (fin 49)
25	3,6	x
(Fin 25)	3,9	x
	4,2	x
	4,5	x
	4,8	x

Sawn Products

Setra supply and offer a wide range of sawn timber, redwood pine (Pinus Sylvestris) products and whitewood spruce (Picea Abies). Products are all kiln dried, available in various grades and length specifications.

All stocks are available from undercover Ex Quay facilities at King's Lynn and Hull. Supplied in full loads, half loads, individual packs and smaller volumes to meet customer requirements. With regular shipments from Sweden, constantly replenishing our stocks.

Available in FSC® & PEFC



Redwood and Whitewood Sawn

	Redwood Unsorted	Redwood 1-V / Fifths	Redwood Sixths	Whitewood 1-V	Whitewood Sixths
75x225	X	X	X		
75x200	X	X	X		
75x150	X	X	X		
75x125		X	X		
63x225	X	X	X		
63x200		X	X		
50x250	X		X		
50x225	X	X	X		
50x200	X	X	X		
50x175	X	X	X		
50x150	X	X	X		
50x125	X	X	X		
50x100	X	X	X		
47x150	X	X	X	X	
47x100	X	X	X	X	
38x225	X	X	X		
38x200	X	X	X		
38x175	X	X	X		
38x150	X	X	X		
32x225	X	X	X		
32x200	X	X	X		
32x150	X	X	X		
25x225	X	X	X		
25x200	X	X	X		
25x175	X	X	X		
25x150	X	X	X		
25x125	X	X	X		
25x100	X	X	X		
25x75		X	X		
22x150				X	X
22x125				X	X
22x100				X	X
22x75				X	X
19x150	X	X	X	X	X
19x125	X	X	X	X	X
19x100	X	X	X	X	X
19x75	X	X	X	X	X

Structural Timber

C24 Carcassing

Kiln-Dried raw material supplied from Sweden ensures consistent and stable grading to C24.

Setra Hasselfors is producing Structural Grade Whitewood at it's brand new planing line, fully commissioned during Autumn 2020.

All available for collection or delivery from our landed stock in King's Lynn.

CLS

Quality Swedish KD whitewood produced from Setra raw material at our Hasselfors mill to suit UK specification.

Single Packs, Half & Full Loads available from our Ex Quay Landed Stock operation.



C24 Carcassing (Treated UC2 & Untreated)
Available stock lengths may vary

Nominal Thickness (mm)	Profile	Nominal Lengths (mm)	Nominal Width (mm)						
			75	100	125	150	175	200	225
47	Whitewood	2.4	X	X		X			
	Regularised & Eased	3.0	X	X		X			
	4 Corners	3.6	X	X	X	X	X	X	X
		4.2	X	X	X	X	X	X	X
		4.8	X	X	X	X	X	X	X
50	CLS	5.4				X	X	X	X
		odd	X	X	X	X	X	X	X
		2.4		X					
		3.0		X					

NB 47x75 Sold as C16



CLS

Nominal Thickness (mm)	Profile	Nominal Lengths (mm)	Nominal Width (mm) and Finish Size		
			75 (fin 63)	100 (fin 89)	150 (fin 140)
50	Regularised	2,4	x	x	
(Fin 38)		3,0	x	x	
		4,8		x	x

Structural Timber

TR26

TR26 is a special grade developed exclusively for UK trussed rafter fabricators.

The spruce forests which grow close to our Hasselfors plant are very suitable to produce consistent and high quality TR26.

Available ex landed stock Kings Lynn.



TR26 Roof Truss Grade Spruce
Available stock lengths may vary

Nominal Thickness (mm)	Nominal Width (mm)						
Profile	Lengths	75	87	100	125	150	
36 Regularised	2.4						
Square Edged	3.0	X	X	X			
	3.6	X	X	X	X	X	
	4.2	X	X	X	X	X	
	4.8	X	X	X	X	X	
	5.4	X	X	X	X	X	
	odd	X	X	X	X	X	

Nominal Thickness (mm)	Nominal Width (mm)								
Profile	Lengths	75	100	125	150	175	200	225	
47 Regularised	2.4								
Square Edged	3.0	X	X						
	3.6	X	X	X	X	X	X	X	
	4.2	X	X	X	X	X	X	X	
	4.8	X	X	X	X	X	X	X	
	5.4	X	X	X	X	X	X	X	
	odd	X	X	X	X	X	X	X	



Specialist Products From Sweden

Structural Glulam

Glulam is 45mm of lumber layers that are joined together through finger-jointing and gluing, to create a larger beam. The wood is mostly spruce. The result is an environmentally friendly material which is stronger than steel and concrete in relation to its own weight.

Setra's glulam consists of 100 percent Swedish wood, mostly spruce but also pine. We have pride in supplying a real Swedish product, that is renewable and climate friendly. It contributes to a natural environment, both in your home and on a global perspective.

Setra glulam has all the good qualities from the wood and is extremely strong and dimensionally stable. The building material is ideal for all types of structures, but especially useful in buildings with a large span, for example sport halls, churches and apartment blocks.

Setra glulam is also suitable as a supporting structure for outdoor verandas, carports, or garden sheds. You can also build smaller things in glulam. Why not construct a ladder, a dresser or a chair?



Specialist Products From Sweden

Finger-Jointed Components

Produced from carefully graded Redwood, Setra components can be produced with horizontal or vertical finger-joints. Using latest scanning technology, our finger-jointed components can be produced with continuous grain.

Ideal uses are for Setra Finger-Jointed components include window-frame sections, as well as for door frames where stability is important. Consistent appearance and optimal lengths can also be achieved by using finger-jointed components.

Tragolv Flooring

Sourced from slow grown forest, carefully kiln dried to between 10%–12% moisture content and machined in Sweden.

This flooring provides high levels of stability and performance.



Finger Jointed Components

Nominal Thickness (mm)	Nominal Width (mm)					
	50	63	75	100	125	150
74	X	X	X	X	X	X
63	X	X	X	X	X	X
50	X	X	X	X	X	X
38	X	X	X	X	X	X
32	X	X	X	X	X	X
25	X	X	X	X	X	X

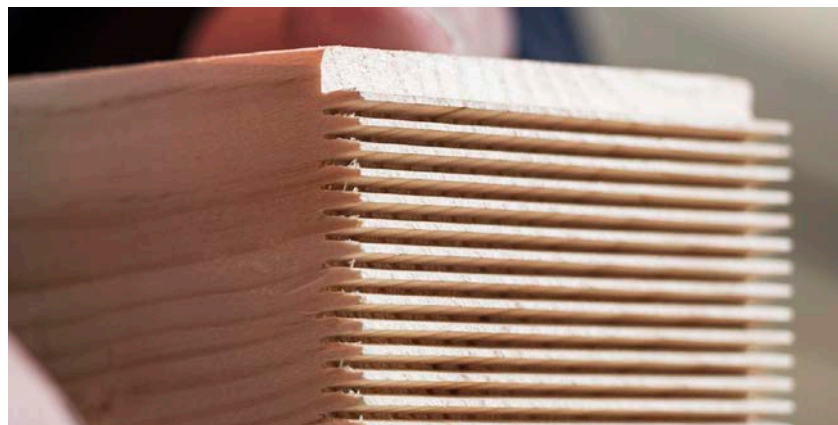

Setra Tragolv Flooring

Nominal Thickness (mm)	Wood Type	Nominal Width (mm)
		125
25	Redwood	X

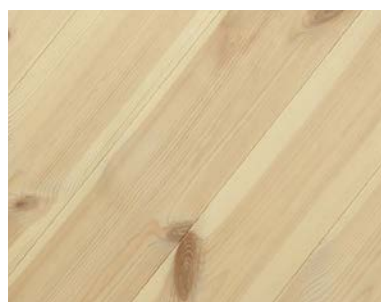

PTG 4 side

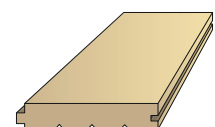

Excellence in Special Machining

Setra Wood Products Ltd operates three in-house machining lines, with a hands-on approach to every piece we machine.

Our team of experienced machinists and mill operatives, combined with high quality raw material, gives us confidence in the production of our machined timber.

Wadkin XJ220

Alongside the Powermats we operate a Wadkin XJ220 with automatic in-feed, out-feed and a length stamping facility.

This machine is suited to longer batch runs and is the perfect compliment to our Powermats.



The Powermat 3000

Our new Weinig Powermat 3000 is reliable, powerful and versatile. It is the focal point of our production facility, and its versatility allows us to maximise our production capabilities to suit our customers requirements.

With its variable spindle speed, fast setting and capability of 80mtrs per minute, this machine enhances our flexibility and production performance. This machine produces outstanding surface quality, even at high feed speeds.

The Powermat 3000 is the new flagship of the Powermat series of machines.

The Powermat 1000

We also operate a Weinig Powermat 1000. This machine has been designed to run short to medium batches and provides a high quality machined finish. Product sizes range from a minimum of 8x25 to maximum of 150x225.

Using state of the art tooling and software technology, our ability to manufacture and supply machined sections to customers own specification provides the perfect complement to our existing range of high quality prepared stocks and mouldings.

Both Powermats

Can produce a wide range of mouldings including:

- Architraves
- Single purpose and reversible skirting boards
- Windowboards and window sections
- Hand rails, base rails, covings and cover strips
- PTG Flooring
- Small beadings (Scotia, Quadrant, Parting Beads etc)
- PAR to special finish sizes or rounded/eased corners

Additional Added-Value Services

White Priming

Timber is primed with a high-opacity primer using a single vacuum coat application.

The primer contains an anti-mould/anti-fungal protection and provides a basecoat prior to final finishing.

Ideal for internal items such as skirtings, architraves, door linings and stops, and for roof components such as fascias and barge boards.



Preservative Treated

Green (High pressure) Treatment

A waterborne, alkaline/copper-based preservative system developed to provide long-term protection of timber.

1. Interior use only – **Use Class 2 (UC2)**
2. Exterior use above ground – **Use Class 3U (UC3u)**
3. Ground contact – **Use Class 4 (UC4)**

Machined or regularised Nordic whitewood is limited to use class 2

Protects against wood-decaying fungi and attack from wood-destroying insects.

Moisture, sun and outdoor conditions may cause the timber to show signs of weathering. Regular maintenance by way of a brush-applied timber treatment is highly recommended.

Clear (Low pressure) treatment

Acts as a surface coat and is applied to timber at a low pressure for a short amount of time.

Suitable for internal and external use for joinery projects not in contact with the ground or surface water.

The treatment protects timber against wood-decaying fungi and attack from wood destroying insects.

As with green high-pressure treatment, moisture, sun and outdoor conditions may cause the project to show signs of weathering. Regular maintenance by way of a brush-applied timber treatment or paint/stain will again be required.

Environmental and Sustainability

Subject to the constraints imposed by its financial and technical resources, Setra Wood Products Ltd conducts its operations in such a way that the impact on the environment is minimized.

Wood, our key raw material, is a renewable and eco-cycle compliant resource. The procurement of forestry products from companies that source their timber from environmentally managed forests is a key element of Setra Wood Products Ltd's policy.



In adherence to its 'Environmental Policy' Setra Wood Products Ltd will -

- Within the framework of its management system, establish and follow up tangible environmental targets for its operations.
- Comply with laws and other relevant requirements relating to the environment that concern its business.
- Procure timber raw material from suppliers with PEFC or FSC® certification.
- Assess criteria ahead of the purchase of goods and services for their impact on the external and working environment.
- Influence suppliers and other partners so that they contribute to compliance with Setra Wood Products' environmental policy.
- Ensure that all employees have the competence and resources to enable compliance with the requirements and intentions of the environmental policy.
- Communicate with employees, customers and other stakeholders in an open and objective manner on matters concerning the environment.



Ask us about our FSC® certified products.



Our Team

Contact us

Address:

Setra Wood Products Ltd
Estuary Road, King's Lynn
NORFOLK PE30 2HJ, UK

Telephone: +441553 760071

E-mail: mail@setrawoodproducts.com

Website:

www.setrawoodproducts.com

LinkedIn: Setra Group



Stuart Newman
Managing Director
Phone: +44 1553 760071
Mobile: +447775 628081
stuart.newman@setragroup.com



Jason Dodd
Sales Manager
Phone: +44 1553 760071
Mobile: +447786 332718
jason.dodd@setragroup.com



Bill Urmston
Sales Accounts Manager
Landed Stock
Phone: +44 1482 87 00 35
Mobile: +44 7710 905 752
bill.urmston@setragroup.com



Gary Withers
Internal Sales Accounts
Manager
Phone: +44 1553 760071
Mobile: +447557 257320
gary.withers@setragroup.com



Shaun White
Sales Accounts Manager
for South East & London
Phone: +44 1553 760071
Mobile: +447799 624434
shaun.white@setragroup.com



Keith Parsons
Sales Accounts Manager
Landed Stock
Phone: +44 1304 38 0552
Mobile: +44 7714 14 6699
keith.parsons@setragroup.com



Kevin Mummery
Sales Accounts Manager
for Midlands & North East
Phone: +44 1553 760071
Mobile: +447771 770324
kevin.mummery@setragroup.com



Lee Tucker
Sales Accounts Manager
for South West & Wales
Phone: +44 1553 760071
Mobile: +447884 492458
lee.tucker@setragroup.com



Abbey Johnson
Sales
Customer Service
Phone: +44 1553 760071
abbey.johnson@setragroup.com



Ellie Mae Nichols
Apprentice
Customer Service
Phone: +44 1553 760071
ellie-mae.nichols@setragroup.com



Ashleigh Chowns
Internal Sales
Customer Service
Phone: +44 1553 760071
ashleigh.chowns@setragroup.com



Susan Loveridge
Despatch Clerk
Phone: +44 1553 760071
susan.loveridge@setragroup.com



Hilary Walls
Internal Landed Stock
Customer Service
Phone: +44 1482 870035
hilary.walls@setragroup.com



Kevin Cox
Purchase Manager
Phone: +44 1553 760071
kevin.cox@setragroup.com



Adele Hardy
Administration Assistant
Phone: +44 1553 760071
adele.hardy@setragroup.com



Aaron Walker
Materials Planner
Phone: +44 1553 760071
aaron.walker@setragroup.com



David Lambourne
Production Planner
Phone: +44 1553 760071
david.lambourne@setragroup.com



Sarah York
Office/Accounts Manager
Phone: +44 1553 760071
sarah.york@setragroup.com



Sarah Bennett
Despatch Clerk
Phone: +44 1553 760071
sarah.bennett@setragroup.com

Setra Wood Products Ltd

We machine and hold stocks of high quality Scandinavian planed goods, and distribute these nationwide. We hold landed stocks and sell sawn packs of joinery quality pine and spruce, glulam and C24 structural softwood throughout the UK. Our team is also responsible for supplying bulk softwood direct from Setra Sawmills in Sweden.



We create green value.

Setra Wood Products Ltd
Estuary Road
King's Lynn
NORFOLK PE30 2HJ, UK
Telephone: +44 1553 76 00 71

www.setrawoodproducts.com